

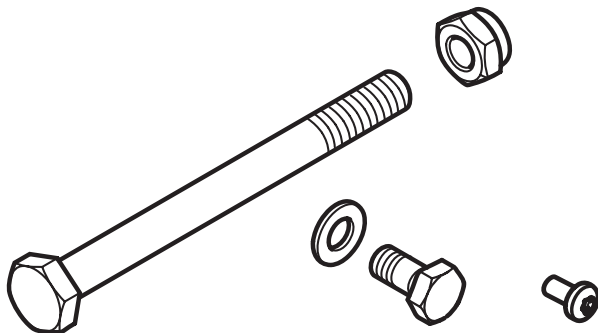

RINGFEDER



RINGFEDER® Screw kit, Cover plate





BG Монтаж
CS Montáž
DA Montering
DE Montage
EL Συναρμολόγηση
EN Installation
ES Montaje
ET Paigaldus
FI Asennus
FR Montage
HU Szerelés
IT Montaggio
JA 取付け
LT Montavimas
LV Montāžas
NL Montage
PL Montażowa
PT Instalação
RO Montaj
RU Монтаж
SK Montáž
SL Montáž
SV Montering
TR Montaj
ZH 安装



BG Демонтаж
CS Demontáž
DA Afmontering
DE Demontage
EL αποσυναρμολόγηση
EN Dismantling
ES Desmontar
ET Demonteerimine
FI Purkaminen
FR Démontage
HU Szétszerelése
IT Smantellamento
JA 解体
LT Išmontavimo
LV Demontāžas
NL Demontage
PL Demontaż
PT Desmontar
RO Demontare
RU Демонтаж
SK Demontáž
SL Razstavljanje
SV Demontering
TR Sökülmesi
ZH 拆除



BG Проверка на функционалността
CS Funkční kontrola
DA Funktionskontrol
DE Funktionskontrolle
EL Έλεγχος λειτουργίας
EN Function check
ES Controles de funciones
ET Funktsiooni kontroll
FI Toiminnan tarkastus
FR Vérification des fonctions
HU Működés ellenőrzés
IT Controllo funzioni
JA 機能コントロール 操作 ール
LT Veikimo patikra
LV Funkciju pārbaude
NL Functiecontrole
PL Kontrola działania
PT Verificação de funcionamento
RO Control funcționare
RU Контроль функций
SK Kontrola funkcie
SL Kontrola delovanja
SV Funktionskontroll
TR Fonksiyon kontrolü
ZH 功能开关

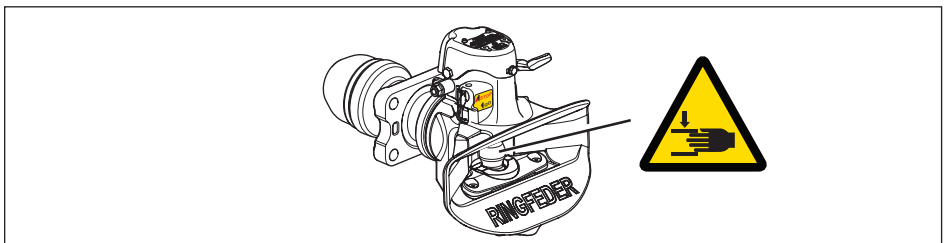
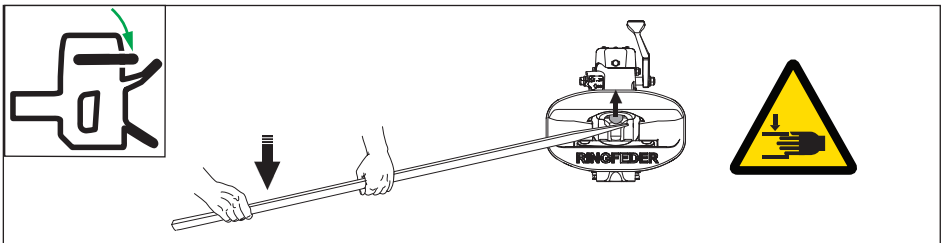



- BG** Опасност - Ръката може да се премажев
CS Nebezpečí - Pohmoždění rukou
DA Klemmerisiko!
DE Klemmgefahr!
EL Κίνδυνος - Σύνθλιψη του χεριού
EN Pinch point!
ES Peligro - aplastamiento de manos
ET Vigastusoht – käsi saab muljuda
FI Puristumisvaara
FR Risque d'écrasement
HU Loukkaantumisvaara – käsi jää puristuksiin
IT Pericolo schiacciamento mani
JA 手の圧傷の危険
LT Pavojus – gali būti suspausta ranka
LV Traumu risks
NL Risico op beknelling!
PL Ryzyko zakleszczenia
PT Risco - poderá entalar os dedos.
RO Pericol - mâna poate fi strivită
RU Риск защемления!
SK Nebezpečenstvo pomliaždenie ruky
SL Nevarnost - lahko vam zmečka roko
SV Klämrisk
TR Tehlikesi - Parmaklar sıkışabilir
ZH 受伤危险 – 手伸入



- BG** Прикачното устройство затворено и фиксирано
CS Závěs spojen a zajištěn
DA Kobling lukket og sikret
DE Kupplung geschlossen und gesichert
EL Σύνδεσμος κλειστός και ασφαλισμένος
EN Coupling closed and secured
ES Enganche cerrado y asegurado
ET Haakesead e suletud ja kontrollitud
FI Vetokytin kiinni ja varmistettu
FR Attelage fermé et verrouillé
HU Vonószerkezet lezárva és biztosítva
IT Giunto di accoppiamento chiuso e bloccato
JA カプラー閉固定 状態
LT Jungtis uždaryta ir įtvirtinta
LV Vonószerkezet lezárva és biztosítva
NL Koppeling gesloten en beveiligd
PL Sprzęg zamknięty i zabezpieczony
PT Engate fechado e bloqueado
RO Cuplă închisă și asigurată
RU Сцепное устройство закрыто и заблокировано
SK Spojka uzatvorená a zaistená
SL Priklopna naprava zaprta in zavarovana
SV Koppling stängd och säkrad
TR Kavrama kapalı ve emniyete alınmış
ZH 连接装置闭合并 固定

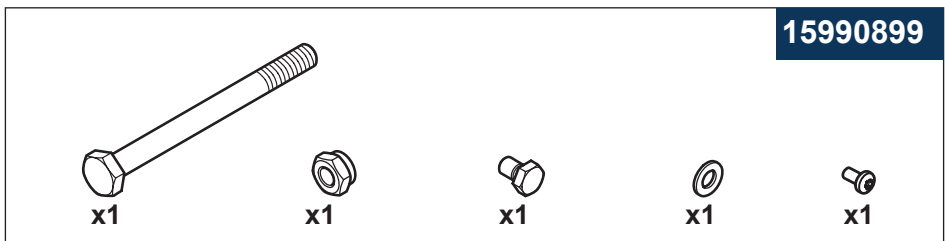

BG Обща информация

Преди монтаж проверете всички части. Монтажът и обслужването трябва да бъдат извършени внимателно и професионално.

CS Obecné informace

Před instalací zkontrolujte, zda máte k dispozici všechny potřebné díly. Instalaci a servis je nutno provádět pečlivě a odborně.

DA Generelt

Kontroller, at alle dele er til stede inden montering. Montering og service skal udføres på en grundig og professionel måde.

DE Allgemeines

Vor der Installation sind sämtliche Teile zu identifizieren. Installations- und Wartungsarbeiten müssen sorgfältig und fachmännisch erfolgen.

EL Γενικά

Εντοπίστε όλα τα εξαρτήματα πριν από την εγκατάσταση. Η εγκατάσταση και το σέρβις πρέπει να πραγματοποιούνται προσεκτικά και επαγγελματικά.

EN General

Identify all parts before installation. Installation and service shall be carried out carefully and professionally.

ES General

Identifique todos los componentes antes de proceder al montaje. La instalación y el mantenimiento deben llevarse a cabo con atención y profesionalidad.

ET Üldist

Enne paigaldamist määratlege kõik osad. Paigaldamine ja hooldus tuleb teha hoolikalt ja professionaalselt.

FI Yleistä

Tunnista kaikki osat ennen asennuksen aloittamista. Asennus ja huolto on suoritettava huolellisesti ja ammattimaisesti.

FR Généralités

Identifiez toutes les pièces avant le montage. Les travaux de montage et d'entretien doivent être effectués de manière soignée et professionnelle.

HU Általános tudnivalók

A telepítés előtt azonosítsa az összes alkatrészt. A telepítést és a szervizelést gondosan és szakszerűen kell elvégezni.

IT Generalità

Identificare tutti i componenti prima di procedere all'installazione. Le attività di installazione e manutenzione devono essere eseguite con cura e in modo professionale.

JA 一般注意事項

取り付け前に、すべての部品を確認してください。取り付けとサービスは、専門知識を持った人が慎重に行ってください。

LT Bendra

Prieš montuodami nustatykite visas dalis. Montavimas ir techninė priežiūra turi būti atliekami kruopščiai ir profesionaliai.

LV Vispārēja informācija

Pirms uzstādīšanas nosakiet visas daļas. Uzstādīšana un apkalpošana ir jāveic uzmanīgi un profesionāli.

NL Algemeen

Controleer vóór installatie of alle onderdelen aanwezig zijn. Installatie en service moeten zorgvuldig en professioneel worden uitgevoerd.

PL Informacje ogólne

Przed przystąpieniem do montażu należy sprawdzić, czy nie brakuje żadnego z elementów. Czynności montażu i konserwacji muszą być prowadzone starannie i w sposób profesjonalny.

PT Geral

Identifique todas as peças antes da instalação. A instalação e o serviço devem ser realizados com cuidado e profissionalismo.

RO Generalități

Identificați toate piesele înainte de instalare. Lucrările de instalare și service trebuie efectuate cu atenție și profesionalism.

RU Общая информация

Перед установкой идентифицируйте все компоненты. Работы по монтажу и техническому обслуживанию следует выполнять аккуратно и профессионально.

SK Všeobecne

Pred inštaláciou identifikujte všetky diely. Inštalácia a servisná údržba sa musia vykonávať starostlivo a odborne.

SL Splošno

Pred namestitvijo spoznajte vse dele. Namestitvev in servis je treba izvesti skrbno in strokovno.

SV Allmänt

Identifiera alla delar före montering. Montering och service skall utföras noggrant och fackmannamässigt.

TR Genel

Kurulumdan önce tüm parçaları gözden geçirin. Kurulum ve servis, dikkatli ve profesyonel bir şekilde gerçekleştirilmelidir.

ZH 一般注意事项

安装前确认所有部件。安装和服务应仔细、专业地进行。

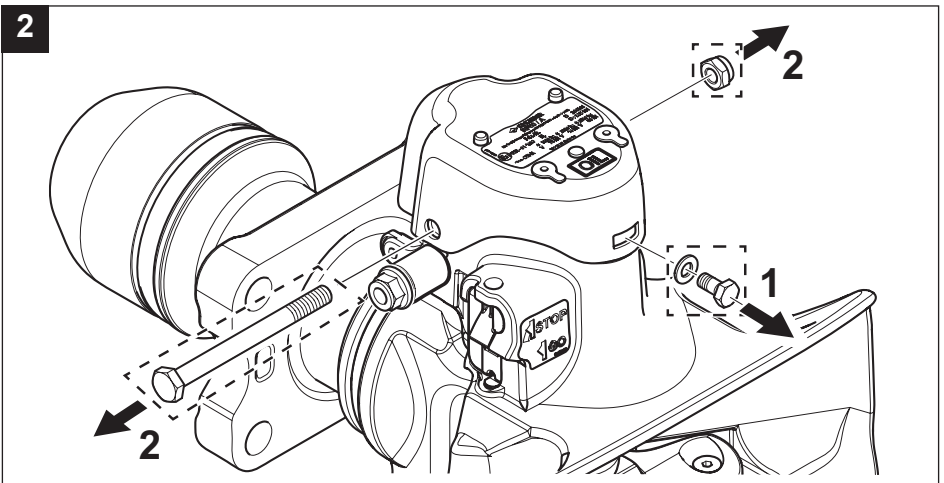
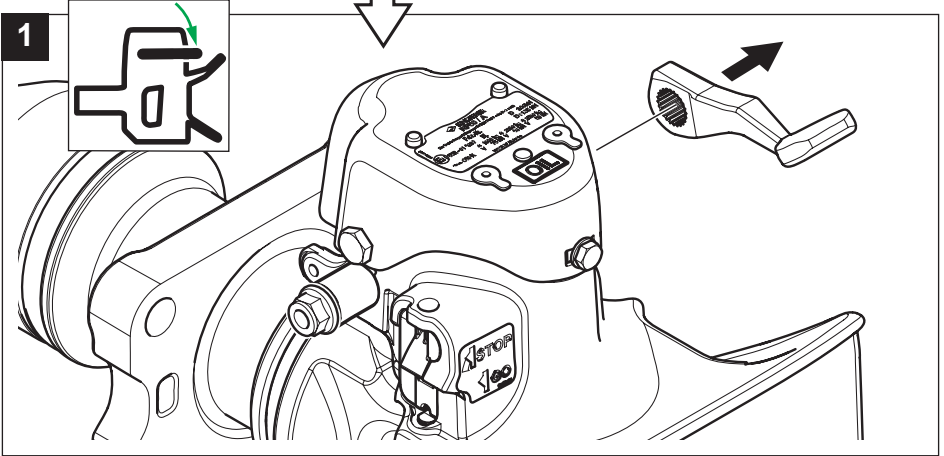
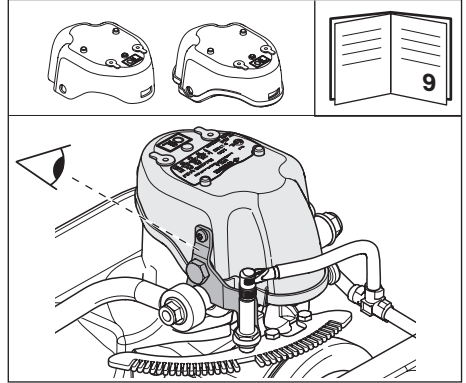
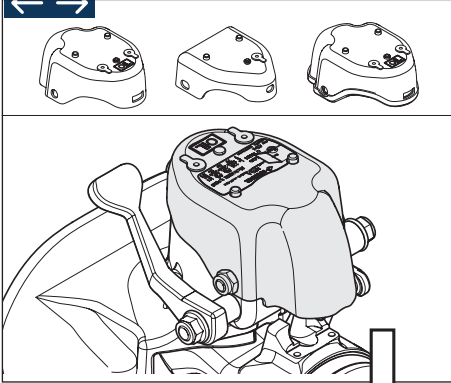



1



25 Nm

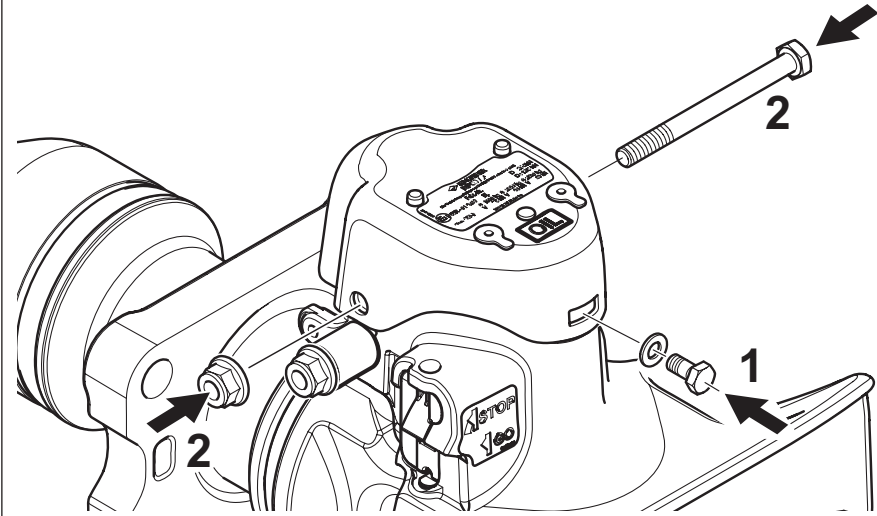

2



60 Nm

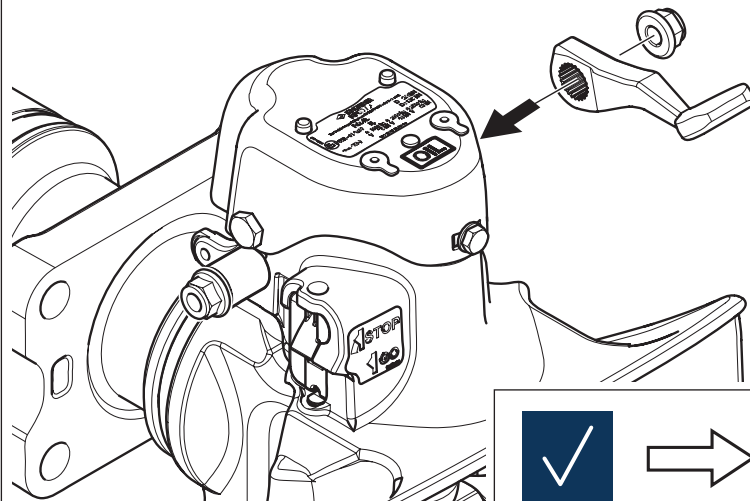

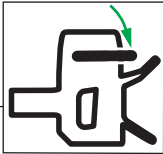

1

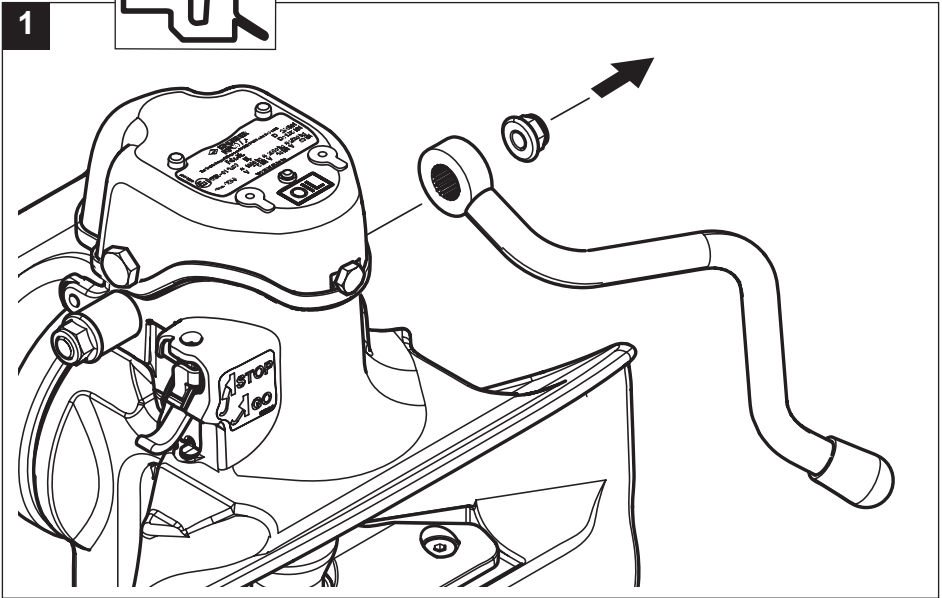

2

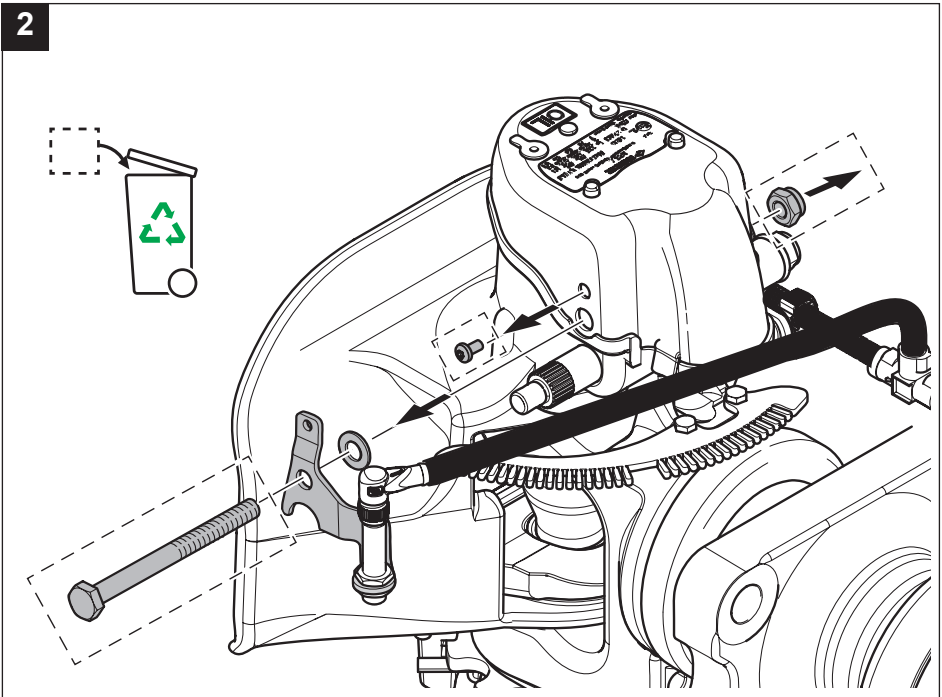



1



25 Nm

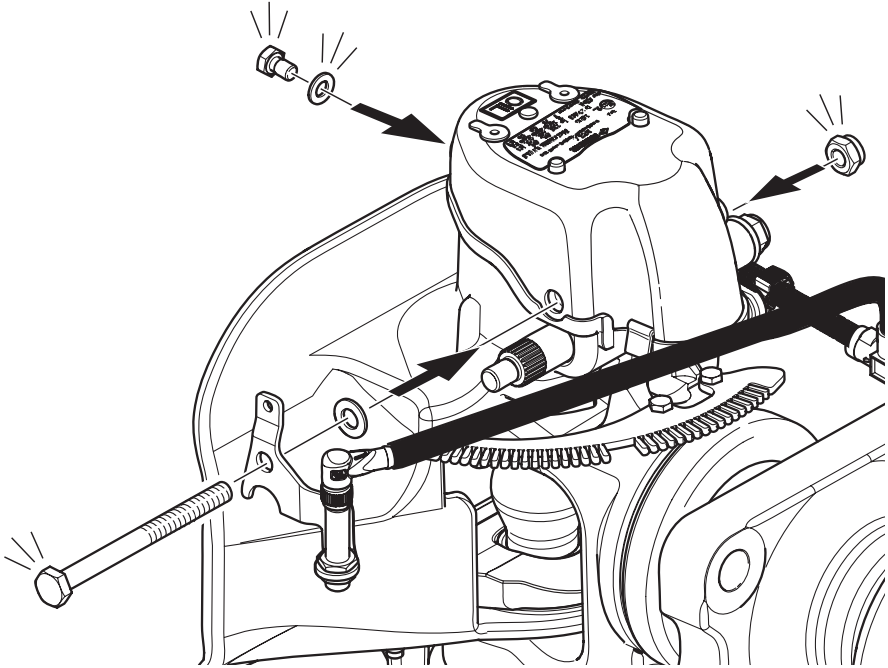

2



6 Nm

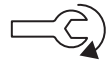
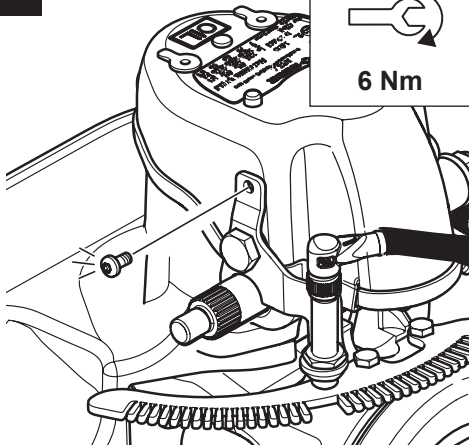

9 Nm



2mm (± 1 mm)

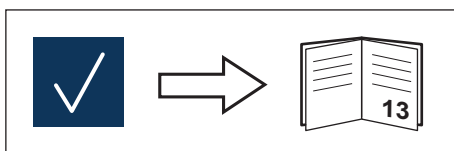
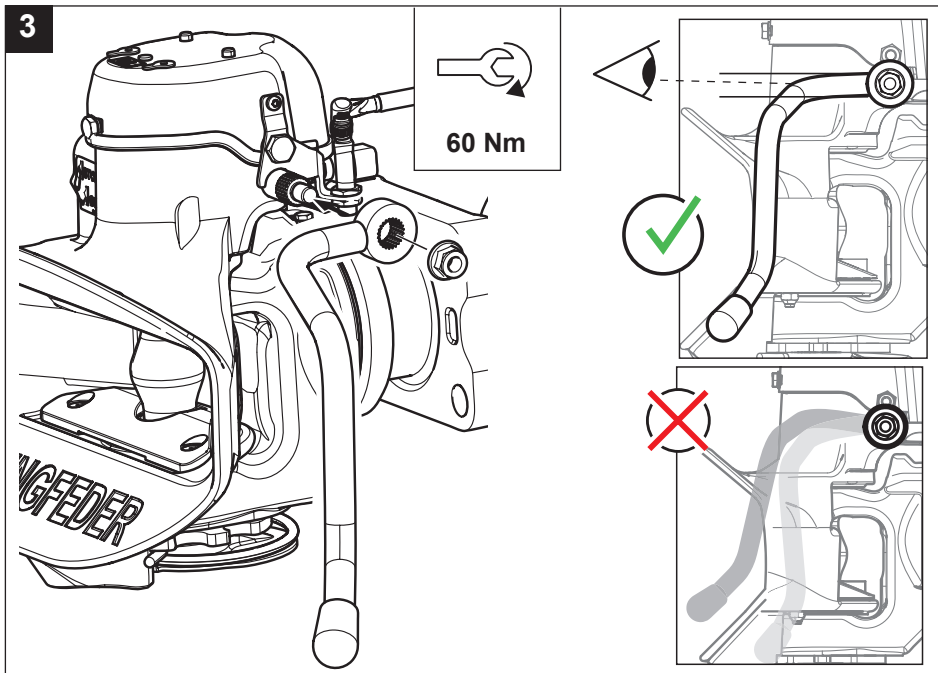



1

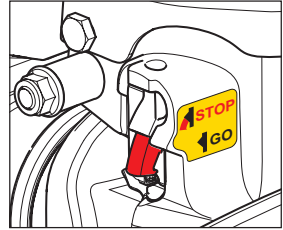
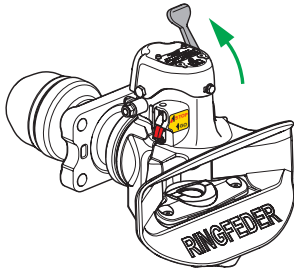

1a

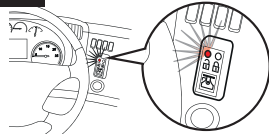

1b

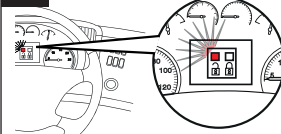

1c

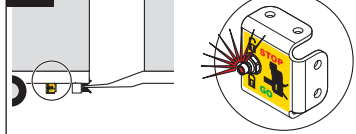

2

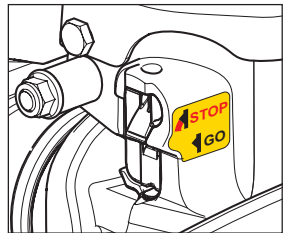
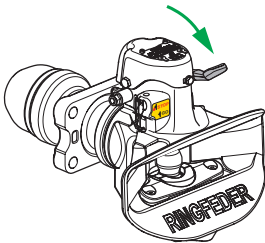
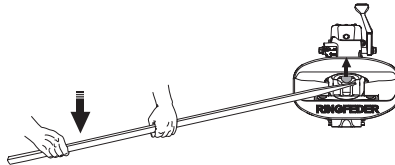

2a

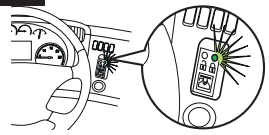

2b

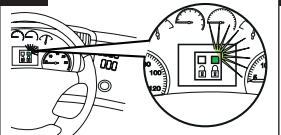

2c

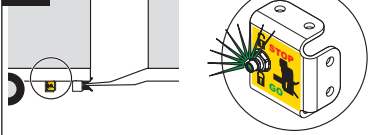



1

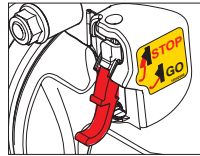
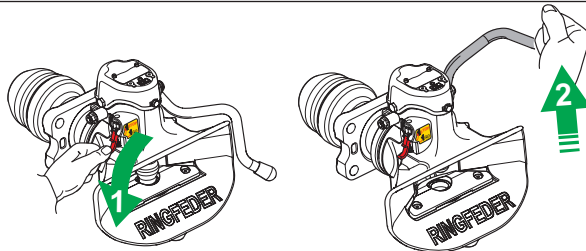

1a

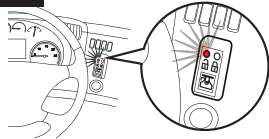

1b

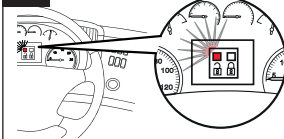

1c



2

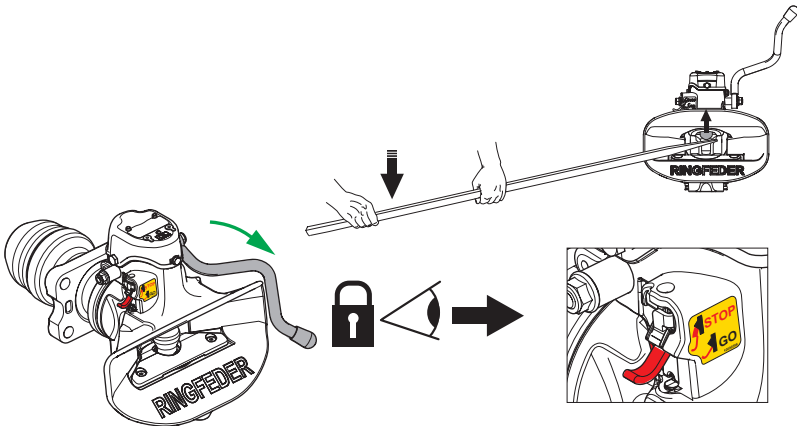

2a

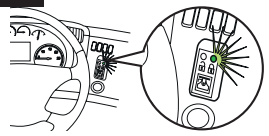

2b

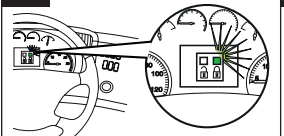

2c

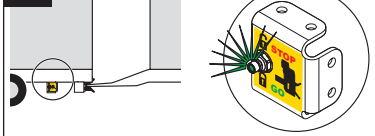



Produced in a certified company

VBG GROUP TRUCK EQUIPMENT GMBH · Girmesgath 5 · D-47803 Krefeld
www.ringfeder-rf.com

 MEMBER OF VBG GROUP